

<p><i>Specification available from:</i> Österreichischer Verband für Elektrotechnik (OVE) A-1010 Wien, Eschenbachgasse 9</p>	<p>IEC 61051-2-2 AT0002 Issue 4 / 2018-04</p> <p>QC 420102 AT0001</p>
<p><i>Electronic components of assessed quality in accordance with:</i> IEC 61051-1: 2007-04 IEC 61051-2: 1991-01 IEC 61051-2, Amendment 1: 2009-05 IEC 60950-1, Annex Q: 2013-05 IEC 62368-1: 2014-02 Annex G.8.2 QC 420000</p>	<p>IEC 61051-2-2: 1991-01 QC 420102</p>
<p>Outline drawing for SFS*-types (see 1.2.1)</p> 	<p>ZINC OXYDE SURGE SUPPRESSION VARISTORS Fail-safe and ThermoFuse Series</p> <p>Insulated</p>
<p>Outline drawing for ETFV14*-types (see 1.2.1)</p> 	<p>Assessment level: E</p>
<p>Outline drawing for ETFV20*-types (see 1.2.1)</p> 	

Outline drawing for ETFV25*-types (see 1.2.1)

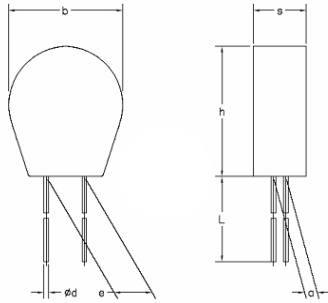

Outline drawing for T14/T20 LV*-types (see 1.2.1)

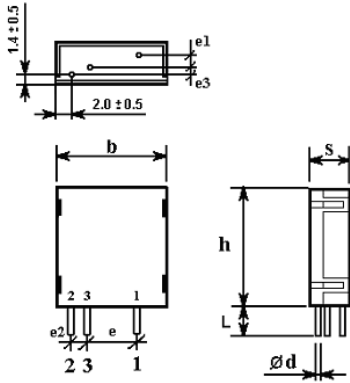
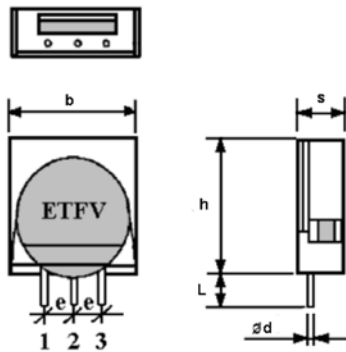
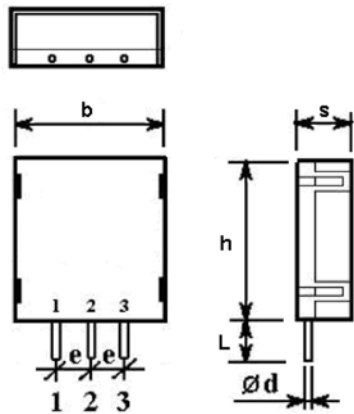
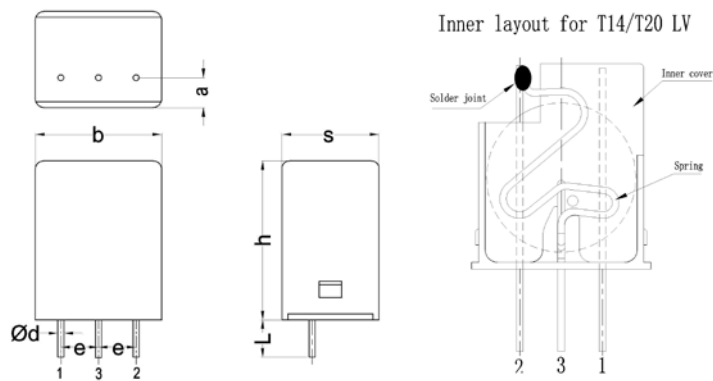

Outline drawing for T20 MV/HV*-types (see 1.2.1)

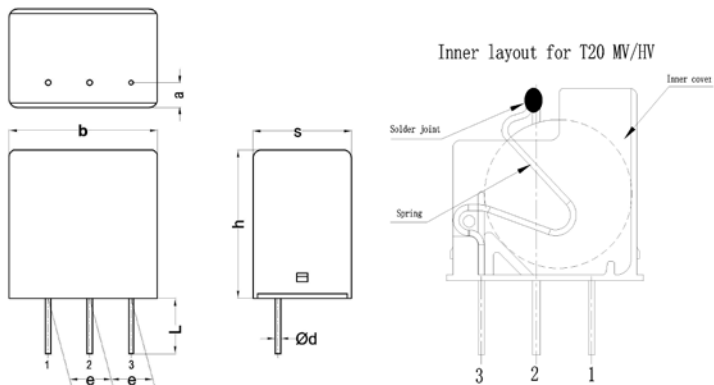

Outline drawing for NT14/NT20-types (see 1.2.1)

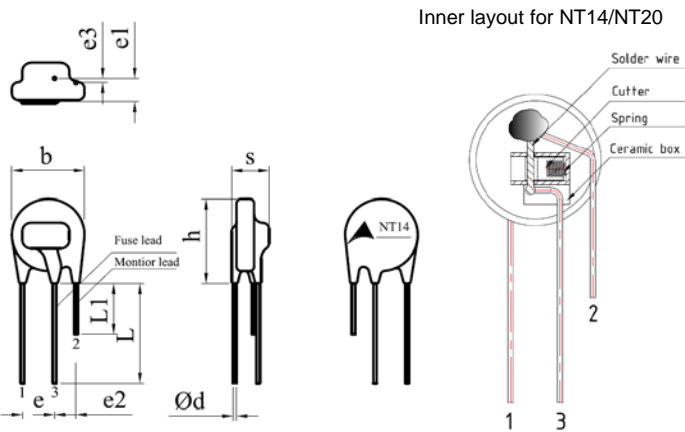

NOTES

- 1 - Other shapes and crimp styles are permitted within the dimensions given.
- 2 - The undimensioned details do not affect the performance of the device.
- 3 - The terminations are suitable for soldering.
- 4 - The terminations are suitable for printed wiring applications.
- 5 - The terminations are rigid.
- 6 - Brief product description according page 3. Lead configuration according Appendix.
- 7 - The Varistors mounted in housing are certified according to IEC 61051-2-2 AT0001.

Information on the availability of components qualified to this detail specification is given in the Qualified Products List.

SECTION ONE – GENERAL DATA

1 General data

Brief product description

A) Fail-safe SFS-series

Applications:
Overvoltage protection

Features:

- 1) Plastic housing protected varistor
- 2) No flame or rupture under specified test conditions
- 3) Plastic substance: Organic Polymer (PPS+ Glass fibre)

B) ThermoFuse ETFV-series

Applications:
Overvoltage protection with integrated thermal fuse
Suitable for use in industrial and household appliance applications

Features:

- 1) Third lead for monitoring purposes
- 2) Failure safe for abnormal over voltage
- 3) Plastic substance: Organic Polymer (Poly butylene terephthalate + Glass fibre)

C) ThermoFuse T-series

Applications:
Overvoltage protection with integrated thermal fuse
Suitable for use in industrial and household appliance applications

Features:

- 1) Third lead for monitoring purposes
- 2) Failure safe for abnormal over voltage
- 3) Meet thermal stability according to section 8.3.5.2 of IEC 61643-11
- 4) Plastic substance: Organic Polymer (Plastic housing inner cover- Aromatic Liquid Crystal Polymer (LCP)+ Glass fibre; Plastic housing outer cover- Poly butylene terephthalate (PBT) + Glass fibre.

d) ThermoFuse NT-series

Applications:
Overvoltage protection with integrated thermal fuse
Suitable for use in industrial and household appliance applications

Features:

- 1) Third lead for monitoring purposes
- 2) Failure safe for abnormal over voltage

Details to lead configuration see Appendix.

1.1 Recommended method (s) of mounting

The varistors shall be mounted by their normal means in such a manner that there shall be no parasitic vibration.

1.2 Dimensions, ratings and characteristics (see table 1)

1.2.1 Dimensions (All dimensions are in millimeters)

- Body diameter: b see table 1
- Body thickness (including terminations of styles with wire terminations): s see table 1
- Diameter of wire terminations: d see below
- Length of wire termination: l ETFV: $5 \pm 0.5\text{mm}$
T14: $5 \pm 0.5\text{mm}$
T20: $10 \pm 0.5\text{mm}$
Other: $l_{\text{min}} = 25\text{ mm}$
 $l_{\text{min}} = 6\text{mm}$
- Distance between wire terminations: e see below

e [mm] ± 1.0	5.0	7.1	7.5	10.0	12.7
ϕ d [mm] ± 0.05	0.6	0.8	0.8	1.0	1.0
SFS14	R5	R7	*	R10	---

Style ETFV14	e	e1	e2	e3
e~e3 [mm] ± 0.5	7.5	5.0	5.0	1.0
ϕ d [mm] ± 0.05	0.8			

e [mm] ± 0.5	5.0	6.35	7.5
ϕ d [mm] ± 0.05	0.8	1.0	1.0
Style ETFV20	*	---	---
Style ETFV25	---	*	---
Style T14	*	---	---
Style T20 LV	*	---	---
Style T20 MV/HV	---	---	*

* Default varistor types ("R" is omitted)

Style NT14/NT20 LV	e	e1	e2	e3
e~e3 [mm] ± 1.0	7.5	*	5.0	1.0
ϕ d [mm] ± 0.05	0.8			

Style NT20 HV	e	e1	e2	e3
e~e3 [mm] ±1.0	7.5	*	5.0	1.0
φ d [mm] ± 0.05	1.0			

* Default varistor types ("e1" is omitted)

1.2.2 Ratings and characteristics

Climatic category:	40/85/56
LCT/UCT (Lower/Upper category temperature) ¹⁾	-40°C/85°C
Maximum continuous a.c. voltage:	see table 1
Maximum continuous d.c. voltage:	see table 1
Supply voltage:	see table 1
Voltage at specified current (1 mA):	
- at 25°C	see table 1
- if applicable, at upper category temperature:	-
- if applicable, at ... °C	-
Maximum peak current:	
- for 10 pulses 8/20 μs at 2 per min:	see table 1 and 1.2.3
- for 10 pulses 10/1 000 μs or 2 ms square wave at 1 every two min:	see table 1 and 1.2.3
Class current:	see table 1
Voltage at class current (protection level):	see table 1
Capacitance:	see table 1
Isolation voltage (insulated varistors only):	2500 V (a.c.)
Maximum temperature coefficient of the voltage at specified current	-(0.09 % / K)max.

1.2.3 Derating curve

Maximum peak current ratings: See 1.3/ Table 1

Maximum continuous a.c. or d.c. voltage with temperature

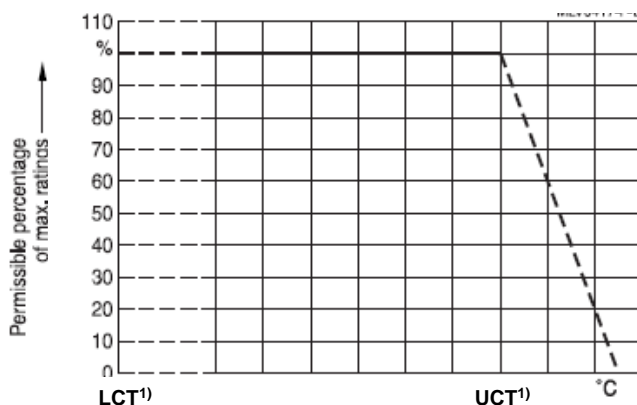

¹⁾ LCT/UCT: Lower/Upper category temperature = Operating temperature range.

1.3 Related documents

Generic specification:	IEC Publication 61051-1: Varistors for Use in Electronic Equipment. Part 1: Generic Specification.
Sectional specification:	IEC Publication 61051-2: Varistors for Use in Electronic Equipment. Part 2: Sectional Specification for Surge Suppression Varistors.
Detail specification:	IEC 61051-2-2 AT0001: Detail Specification for leaded Disk / Square Varistors

Table 1 (1 of 9)

Style (1)	IEC 61051-2-2 AT0001: Detail Specification for leaded Disk	Supply voltage (3)	Maximum continuous voltage		Voltage at 1 mA (V)	Voltage at class current (8/20µs)		Max. peak current (8/20µs, 1 time) (A)	Max. peak current (8/20µs, 10 times) (A)	Max. peak current (8/20µs, combination pulse, 10 times) (A)	Max. peak current (2 ms, 10 times) (A)	Maximum capacitance (pF)	Dimensions		
			r.m.s. (V)	d.c. (V)		Class current(A)	Max. volt (V)						bmax (mm)	hmax (mm)	smax (mm)
*SFS14K130E2	S14K130E2	120	130	170	205	50	340	6000	3000	6.0kV/3.0kA	35.4	1900	20	23.1	9.2
*SFS14K140E2	S14K140E2		140	180	220	50	360	6000	3000	6.0kV/3.0kA	35.4	1750	20	23.1	9.2
*SFS14K150E2	S14K150E2		150	200	240	50	395	6000	3000	6.0kV/3.0kA	35.4	1600	20	23.1	9.2
*SFS14K175E2	S14K175E2		175	225	270	50	455	6000	3000	6.0kV/3.0kA	35.4	1380	20	23.1	9.2
*SFS14K210E2	S14K210E2		210	270	330	50	545	6000	3000	6.0kV/3.1kA	35.4	1250	20	23.1	9.2
*SFS14K230E2	S14K230E2		230	300	360	50	595	6000	3000	6.0kV/3.0kA	35.4	1100	20	23.1	9.2
*SFS14K250E2	S14K250E2		250	320	390	50	650	6000	3000	6.0kV/3.0kA	35.4	940	20	23.1	9.2
*SFS14K275E2	S14K275E2		275	350	430	50	710	6000	3000	6.0kV/3.0kA	35.4	900	20	23.1	9.2
*SFS14K300E2	S14K300E2	230/240	300	385	470	50	775	6000	3000	6.0kV/3.0kA	35.4	780	20	23.1	9.2
*SFS14K320E2	S14K320E2		320	420	510	50	840	6000	3000	6.0kV/3.0kA	35.4	680	20	23.1	9.2
*SFS14K350E2	S14K350E2		350	460	560	50	910	5000	3000	6.0kV/3.0kA	27.8	675	20	23.1	9.2
*SFS14K385E2	S14K385E2		385	505	620	50	1025	5000	3000	6.0kV/3.0kA	27.8	670	20	23.1	9.2
*SFS14K420E2	S14K420E2		420	560	680	50	1120	5000	3000	6.0kV/3.0kA	27.8	600	20	23.1	9.2
*SFS14K460E2	S14K460E2		460	615	750	50	1240	5000	3000	6.0kV/3.0kA	27.8	570	20	23.1	9.2

- (1) For explanation of style reference number, see clause 1.5.
(2) All types marked with "*" are covered by IEC 62368-1 G.8.2 and IEC 60950-1 Annex Q.
(3) Acc. To IEC 62368-1 G.8.2 and IEC60950-1, Annex Q: Maximum continuous voltage of the Varistors should be at least 1.25 times rated voltage of equipment/ rated voltage range. Only typical AC Mains Supply voltages are indicated.

Table 1 (2 of 9)

Style (1)	IEC 61051-2-2 AT0001: Detail Specification for leaded Disk	Supply voltage (3)	Maximum continuous voltage		Voltage at 1 mA (V)	Voltage at class current (8/20µs)		Max. peak current (8/20µs, 1 time) (A)	Max. peak current (8/20µs, 10 times) (A)	Max. peak current (8/20µs, combination pulse, 10 times) (A)	Max. peak current (2 ms, 10 times) (A)	Maximum capacitance (pF)	Dimensions							
			r.m.s. (V)	d.c. (V)		Class current(A)	Max. volt (V)						(A)	(A)	(A)	(A)	(pF)	bmax	hmax	smax
																		(mm)	(mm)	(mm)
*ETFV14K115E2	S14K115E2	-	115	150	180	50	300	6000	3000	6.0kV/3.0kA	35.4	2200	20	22	12.0					
*ETFV14K130E2	S14K130E2		130	170	205	50	340	6000	3000	6.0kV/3.0kA	35.4	1900	20	22	12.0					
*ETFV14K140E2	S14K140E2		140	180	220	50	360	6000	3000	6.0kV/3.0kA	35.4	1750	20	22	12.0					
*ETFV14K150E2	S14K150E2		150	200	240	50	395	6000	3000	6.0kV/3.0kA	35.4	1600	20	22	12.0					
*ETFV14K175E2	S14K175E2		175	225	270	50	455	6000	3000	6.0kV/3.0kA	35.4	1380	20	22	12.0					
*ETFV14K210E2	S14K210E2		210	270	330	50	545	6000	3000	6.0kV/3.1kA	35.4	1250	20	22	12.0					
*ETFV14K230E2	S14K230E2		230	300	360	50	595	6000	3000	6.0kV/3.0kA	35.4	1100	20	22	12.0					
*ETFV14K250E2	S14K250E2		250	320	390	50	650	6000	3000	6.0kV/3.0kA	35.4	940	20	22	12.0					
*ETFV14K275E2	S14K275E2		275	350	430	50	710	6000	3000	6.0kV/3.0kA	35.4	900	20	22	12.0					
*ETFV14K300E2	S14K300E2	230/240	300	385	470	50	775	6000	3000	6.0kV/3.0kA	35.4	780	20	22	12.0					
*ETFV14K320E2	S14K320E2		320	420	510	50	845	6000	3000	6.0kV/3.0kA	35.4	680	20	22	12.0					
*ETFV14K350E2	S14K350E2		350	460	560	50	930	5000	3000	6.0kV/3.0kA	27.8	675	20	22	12.0					
*ETFV14K385E2	S14K385E2		385	505	620	50	1025	5000	3000	6.0kV/3.0kA	27.8	670	20	22	12.0					
*ETFV14K420E2	S14K420E2		420	560	680	50	1120	5000	3000	6.0kV/3.0kA	27.8	600	20	22	12.0					

(1) For explanation of style reference number, see clause 1.5.

(2) All types marked with "*" are covered by IEC 62368-1 G.8.2 and IEC 60950-1 Annex Q.

(3) Acc. To IEC 62368-1 G.8.2 and IEC60950-1, Annex Q: Maximum continuous voltage of the Varistors should be at least 1.25 times rated voltage of equipment/ rated voltage range. Only typical AC Mains Supply voltages are indicated.

Table 1 (3 of 9)

Style (1)	IEC 61051-2-2 AT0001: Detail Specification for leaded Disk	Supply voltage (3)	Maximum continuous voltage		Voltage at 1 mA (V)	Voltage at class current (8/20µs)		Max. peak current (8/20µs, 1 time) (A)	Max. peak current (8/20µs, 10 times) (A)	Max. peak current (8/20µs, combination pulse, 10 times) (A)	Max. peak current (2 ms, 10 times) (A)	Maximum capacitance (pF)	Dimensions						
			r.m.s. (V)	d.c. (V)		Class current(A)	Max. volt (V)						(A)	(A)	(A)	(pF)	bmax	hmax	smax
																	(mm)	(mm)	(mm)
*ETFV20K50	S20K50	-	50	65	82	100	135	6500	3000	6.0kV/3.0kA	43.8	9000	23	25.7	11.0				
*ETFV20K115E2	S20K115E2		115	150	180	100	300	10000	3000	6.0kV/3.0kA	55	4000	23	25.7	11.0				
*ETFV20K130E2	S20K130E2		130	170	205	100	340	10000	3000	6.0kV/3.0kA	55	3500	23	25.7	11.0				
*ETFV20K140E2	S20K140E2		140	180	220	100	360	10000	3000	6.0kV/3.0kA	55	3250	23	25.7	11.0				
*ETFV20K150E2	S20K150E2	120	150	200	240	100	395	10000	3000	6.0kV/3.0kA	55	3000	23	25.7	11.0				
*ETFV20K175E2	S20K175E2		175	225	270	100	455	10000	3000	6.0kV/3.0kA	55	2600	23	25.7	11.0				
*ETFV20K210E2	S20K210E2		210	270	330	100	545	10000	3000	6.0kV/3.1kA	55	2300	23	25.7	11.0				
*ETFV20K230E2	S20K230E2		230	300	360	100	595	10000	3000	6.0kV/3.0kA	55	2000	23	25.7	11.0				
*ETFV20K250E2	S20K250E2		250	320	390	100	650	10000	3000	6.0kV/3.0kA	55	1800	23	25.7	11.0				
*ETFV20K275E2	S20K275E2		275	350	430	100	710	10000	3000	6.0kV/3.0kA	55	1800	23	25.7	11.0				
*ETFV20K300E2	S20K300E2		300	385	470	100	775	10000	3000	6.0kV/3.0kA	55	1500	23	25.7	11.0				
*ETFV20K320E2	S20K320E2	230/240	320	420	510	100	845	10000	3000	6.0kV/3.0kA	55	1300	23	25.7	11.0				
*ETFV20K350E2	S20K350E2		350	460	560	100	930	10000	3000	6.0kV/3.0kA	40	1270	23	25.7	11.0				
*ETFV20K385E2	S20K385E2		385	505	620	100	1025	10000	3000	6.0kV/3.0kA	40	1250	23	25.7	11.0				
*ETFV20K420E2	S20K420E2		420	560	680	100	1120	10000	3000	6.0kV/3.0kA	40	1100	23	25.7	11.0				

(1) For explanation of style reference number, see clause 1.5.

(2) All types marked with "*" are covered by IEC 62368-1 G.8.2 and IEC 60950-1 Annex Q.

(3) Acc. To IEC 62368-1 G.8.2 and IEC60950-1, Annex Q: Maximum continuous voltage of the Varistors should be at least 1.25 times rated voltage of equipment/ rated voltage range. Only typical AC Mains Supply voltages are indicated.

Table 1 (4 of 9)

Style (1)	IEC 61051-2-2 AT0001: Detail Specification for leaded Disk	Supply voltage (3)	Maximum continuous voltage		Voltage at 1 mA (V)	Voltage at class current (8/20µs)		Max. peak current (8/20µs, 1 time) (A)	Max. peak current (8/20µs, 10 times) (A)	Max. peak current (8/20µs, combination pulse, 10 times) (A)	Max. peak current (2 ms, 10 times) (A)	Maximum capacitance (pF)	Dimensions		
			r.m.s. (V)	d.c. (V)		Class current(A)	Max. volt (V)						bmax (mm)	hmax (mm)	smax (mm)
*ETFV25K115E4	S25K115E4	120	115	150	180	150	300	20000	10000	6.0kV/3.0kA	197	8000	31	35.2	12.0
*ETFV25K130E4	S25K130E4		130	170	205	150	340	20000	10000	6.0kV/3.0kA	197	7000	31	35.2	12.0
*ETFV25K140E4	S25K140E4		140	180	220	150	360	20000	10000	6.0kV/3.0kA	197	6500	31	35.2	12.0
*ETFV25K150E4	S25K150E4		150	200	240	150	395	20000	10000	6.0kV/3.0kA	197	6000	31	35.2	12.0
*ETFV25K175E4	S25K175E4		175	225	270	150	455	20000	10000	6.0kV/3.0kA	197	5200	31	35.2	12.0
*ETFV25K210E4	S25K210E4		210	270	330	150	545	20000	10000	6.0kV/3.1kA	197	4600	31	35.2	12.0
*ETFV25K230E4	S25K230E4		230	300	360	150	595	20000	10000	6.0kV/3.0kA	197	4000	31	35.2	12.0
*ETFV25K250E4	S25K250E4		250	320	390	150	650	20000	10000	6.0kV/3.0kA	197	3600	31	35.2	12.0
*ETFV25K275E4	S25K275E4		275	350	430	150	710	20000	10000	6.0kV/3.0kA	197	3600	31	35.2	12.0
*ETFV25K300E4	S25K300E4	230/240	300	385	470	150	775	20000	10000	6.0kV/3.0kA	197	3000	31	35.2	12.0
*ETFV25K320E4	S25K320E4		320	420	510	150	845	20000	10000	6.0kV/3.0kA	197	2600	31	35.2	12.0
*ETFV25K350E4	S25K350E4		350	460	560	150	930	20000	10000	6.0kV/3.0kA	197	3540	31	35.2	12.0
*ETFV25K385E4	S25K385E4		385	505	620	150	1025	20000	10000	6.0kV/3.0kA	197	2500	31	35.2	12.0
*ETFV25K420E4	S25K420E4		420	560	680	150	1120	20000	10000	6.0kV/3.0kA	197	2200	31	35.2	12.0

(1) For explanation of style reference number, see clause 1.5.

(2) All types marked with "*" are covered by IEC 62368-1 G.8.2 and IEC 60950-1 Annex Q.

(3) Acc. To IEC 62368-1 G.8.2 and IEC60950-1, Annex Q: Maximum continuous voltage of the Varistors should be at least 1.25 times rated voltage of equipment/ rated voltage range. Only typical AC Mains Supply voltages are indicated.

Table 1 (5 of 9)

Style (1)	IEC 61051-2-2 AT0001: Detail Specification for leaded Disk	Supply voltage (3)	Maximum continuous voltage		Voltage at 1 mA (V)	Voltage at class current (8/20µs)		Max. peak current (8/20µs, 1 time) (A)	Max. peak current (8/20µs, 10 time) (A)	Max. peak current (8/20µs, combination pulse, 10 times) (A)	Max. peak current (2 ms, 10 times) (A)	Maximum capacitance (pF)	Dimensions		
			r.m.s. (V)	d.c. (V)		Class current(A)	Max. volt (V)						bmax (mm)	hmax (mm)	smax (mm)
*T14K130E2	S14K130E2K1	-	130	170	205	50	340	6000	3000	6.0kV/3.0kA	33.6	2600	17.0	21.6	13.0
*T14K150E2	S14K150E2K1	120	150	200	240	50	395	6000	3000	6.0kV/3.0kA	33.6	2000	17.0	21.6	13.0
T14K175E2	S14K175E2K1		175	225	270	50	455	6000	3000	6.0kV/3.0kA	33.6	1800	17.0	21.6	13.0
*T14K230E2	S14K230E2K1		230	300	360	50	595	6000	3000	6.0kV/3.0kA	33.6	1400	17.0	21.6	13.0
*T14K250E2	S14K250E2K1		250	320	390	50	650	6000	3000	6.0kV/3.0kA	33.6	1200	17.0	21.6	13.0
*T14K275E2	S14K275E2K1		275	350	430	50	710	6000	3000	6.0kV/3.0kA	33.6	1100	17.0	21.6	13.0
*T14K300E2	S14K300E2K1		230/240	300	385	470	50	775	6000	3000	6.0kV/3.0kA	33.6	1100	17.0	21.6
*T14K320E2	S14K320E2K1	320		420	510	50	840	6000	3000	6.0kV/3.0kA	33.6	900	17.0	21.6	13.0
*T14K350E2	S14K350E2K1	350		460	560	50	910	6000	3000	6.0kV/3.0kA	33.6	800	17.0	21.6	13.0
*T14K385E2	S14K385E2K1	385		505	620	50	1025	6000	3000	6.0kV/3.0kA	33.6	850	17.0	21.6	13.0
*T14K420E2	S14K420E2K1	420		560	680	50	1120	6000	3000	6.0kV/3.0kA	33.6	750	17.0	21.6	13.0

(1) For explanation of style reference number, see clause 1.5.

(2) All types marked with "*" are covered by IEC 62368-1 G.8.2 and IEC 60950-1 Annex Q.

(3) Acc. To IEC 62368-1 G.8.2 and IEC60950-1, Annex Q: Maximum continuous voltage of the Varistors should be at least 1.25 times rated voltage of equipment/ rated voltage range. Only typical AC Mains Supply voltages are indicated.

Table 1 (6 of 9)

Style (1)	IEC 61051-2-2 AT0001: Detail Specification for leaded Disk	Supply voltage (3)	Maximum continuous voltage		Voltage at 1 mA (V)	Voltage at class current (8/20µs)		Max. peak current (8/20µs, 1 time) (A)	Max. peak current (8/20µs, 10 times) (A)	Max. peak current (8/20µs, combination pulse, 10 times) (A)	Max. peak current (2 ms, 10 times) (A)	Maximum capacitance (pF)	Dimensions		
			r.m.s. (V)	d.c. (V)		Class current(A)	Max. volt (V)						(mm)	(mm)	(mm)
T20 LV		(V)			(V)			(A)	(A)	(A)	(A)	(pF)	(mm)	(mm)	(mm)
*T20K50	S20K50	-	50	65	82	100	135	6500	3000	6.0kV/3.0kA	43.8	9000	22	26	12.0
*T20K130E2	S20K130E2		130	170	205	100	340	10000	3000	6.0kV/3.0kA	55	3500	22	26	12.0
*T20K150E2	S20K150E2	120	150	200	240	100	395	10000	3000	6.0kV/3.0kA	55	3000	22	26	12.0
*T20K175E2	S20K175E2		175	225	270	100	455	10000	3000	6.0kV/3.0kA	55	2600	22	26	12.0
*T20K230E2	S20K230E2		230	300	360	100	595	10000	3000	6.0kV/3.0kA	55	2000	22	26	12.0
*T20K250E2	S20K250E2		250	320	390	100	650	10000	3000	6.0kV/3.0kA	55	1800	22	26	12.0
*T20K275E2	S20K275E2		275	350	430	100	710	10000	3000	6.0kV/3.0kA	55	1800	22	26	12.0
*T20K300E2	S20K300E2	230/240	300	385	470	100	775	10000	3000	6.0kV/3.0kA	55	1500	22	26	12.0
*T20K320E2	S20K320E2		320	420	510	100	845	10000	3000	6.0kV/3.0kA	55	1300	22	26	12.0
*T20K350E2	S20K350E2		350	460	560	100	930	10000	3000	6.0kV/3.0kA	40	1270	22	26	12.0
*T20K385E2	S20K385E2		385	505	620	100	1025	10000	3000	6.0kV/3.0kA	40	1250	22	26	12.0
*T20K420E2	S20K420E2		420	560	680	100	1120	10000	3000	6.0kV/3.0kA	40	1100	22	26	12.0

(1) For explanation of style reference number, see clause 1.5.

(2) All types marked with "*" are covered by IEC 62368-1 G.8.2 and IEC 60950-1 Annex Q.

(3) Acc. To IEC 62368-1 G.8.2 and IEC60950-1, Annex Q: Maximum continuous voltage of the Varistors should be at least 1.25 times rated voltage of equipment/ rated voltage range. Only typical AC Mains Supply voltages are indicated.

Table 1 (7 of 9)

Style (1)	IEC 61051-2-2 AT0001: Detail Specification for leaded Disk	Supply voltage (3)	Maximum continuous voltage		Voltage at 1 mA (V)	Voltage at class current (8/20µs)		Max. peak current (8/20µs, 1 time) (A)	Max. peak current (8/20µs, 10 times) (A)	Max. peak current (8/20µs, combination pulse, 10 times) (A)	Max. peak current (2 ms, 10 times) (A)	Maximum capacitance (pF)	Dimensions			
			r.m.s. (V)	d.c. (V)		Class current(A)	Max. volt (V)						bmax (mm)	hmax (mm)	smax (mm)	
T20MV																
*T20K460	S20K460	-	460	615	750	100	1240	8000	3000	6.0kV/3.0kA	40	1100	27.5	27.5	13.6	
*T20K460E2	S20K460E2		460	615	750	100	1240	10000	3000	6.0kV/3.0kA	40	1100	27.5	27.5	13.6	
*T20K510	S20K510	380	510	670	820	100	1355	6500	3000	8.0kV/4.0kA	40	900	27.5	27.5	13.6	
*T20K510E2	S20K510E2		510	670	820	100	1355	10000	3000	8.0kV/4.0kA	40	900	27.5	27.5	13.6	
*T20K550	S20K550		550	745	910	100	1500	6500	3000	8.0kV/4.0kA	40	700	27.5	27.5	13.6	
*T20K550E2	S20K550E2		550	745	910	100	1500	10000	3000	8.0kV/4.0kA	40	700	27.5	27.5	13.6	
*T20K625	S20K625		625	825	1000	100	1650	6500	3000	8.0kV/4.0kA	40	650	27.5	27.5	13.6	
*T20K625E2	S20K625E2		625	825	1000	100	1650	10000	3000	8.0kV/4.0kA	40	650	27.5	27.5	13.6	
T20HV																
*T20K680	S20K680		690	680	895	1100	100	1815	6500	3000	8.0kV/4.0kA	40	600	27.5	27.5	18.5
*T20K680E2	S20K680E2	680		895	1100	100	1815	10000	3000	8.0kV/4.0kA	40	600	27.5	27.5	18.5	
*T20K1000	S20K1000	690	1000	1465	1800	100	2970	6500	3000	8.0kV/4.0kA	40	400	27.5	27.5	18.5	

(1) For explanation of style reference number, see clause 1.5.

(2) All types marked with "*" are covered by IEC 62368-1 G.8.2 and IEC 60950-1 Annex Q.

(3) Acc. To IEC 62368-1 G.8.2 and IEC60950-1, Annex Q: Maximum continuous voltage of the Varistors should be at least 1.25 times rated voltage of equipment/ rated voltage range. Only typical AC Mains Supply voltages are indicated.

Table 1 (8 of 9)

Style (1)	IEC 61051-2-2 AT0001: Detail Specification for leaded Disk	Supply voltage (3)	Maximum continuous voltage		Voltage at 1 mA (V)	Voltage at class current (8/20µs)		Max. peak current (8/20µs, 1 time) (A)	Max. peak current (8/20µs, 10 times) (A)	Max. peak current (8/20µs, combination pulse, 10 times) (A)	Max. peak current (2 ms, 10 times) (A)	Maximum capacitance (pF)	Dimensions		
			r.m.s. (V)	d.c. (V)		Class current(A)	Max. volt (V)						bmax (mm)	hmax (mm)	smax (mm)
*NT14K130E2	S14K130E2	120	130	170	205	50	340	6000	3000	6.0kV/3.0kA	35.4	1900	17.0	22.0	9.0
*NT14K140E2	S14K140E2		140	180	220	50	360	6000	3000	6.0kV/3.0kA	35.4	1750	17.0	22.0	9.0
*NT14K150E2	S14K150E2		150	200	240	50	395	6000	3000	6.0kV/3.0kA	35.4	1600	17.0	22.0	9.0
*NT14K175E2	S14K175E2		175	225	270	50	455	6000	3000	6.0kV/3.0kA	35.4	1380	17.0	22.0	9.0
*NT14K210E2	S14K210E2		210	270	330	50	545	6000	3000	6.0kV/3.0kA	35.4	1100	17.0	22.0	9.5
*NT14K250E2	S14K250E2	230	250	320	390	50	650	6000	3000	6.0kV/3.0kA	35.4	940	17.0	22.0	9.5
*NT14K275E2	S14K275E2	240	275	350	430	50	710	6000	3000	6.0kV/3.0kA	35.4	900	17.0	22.0	9.5
*NT14K300E2	S14K300E2		300	385	470	50	775	6000	3000	6.0kV/3.0kA	35.4	780	17.0	22.0	11.0
*NT14K320E2	S14K320E2		320	420	510	50	840	6000	3000	6.0kV/3.0kA	35.4	680	17.0	22.0	11.0
*NT14K350E2	S14K350E2		350	460	560	50	910	6000 (4)	3000	6.0kV/3.0kA	27.8	675	17.0	22.0	11.0
*NT14K385E2	S14K385E2		385	505	620	50	1025	6000 (4)	3000	6.0kV/3.0kA	27.8	670	17.0	22.0	11.0
*NT14K420E2	S14K420E2		420	560	680	50	1120	6000 (4)	3000	6.0kV/3.0kA	27.8	600	17.0	22.0	11.0
*NT14K460E2	S14K460E2		460	615	750	50	1240	6000 (4)	3000	6.0kV/3.0kA	27.8	570	17.0	22.0	11.0
*NT14K510E2	S14K510E2		510	670	820	50	1355	6000 (4)	3000	6.0kV/3.0kA	27.8	460	17.0	22.0	12.0
*NT14K550E2	S14K550E2		550	745	910	50	1500	6000 (4)	3000	6.0kV/3.0kA	27.8	350	17.0	22.0	12.0
*NT14K625E2	S14K625E2		625	825	1000	50	1650	6000 (4)	3000	6.0kV/3.0kA	27.8	320	17.0	22.0	13.0
*NT14K680E2	S14K680E2		680	895	1100	50	1815	6000 (4)	3000	6.0kV/3.0kA	27.8	280	17.0	22.0	13.0

- (1) For explanation of style reference number, see clause 1.5.
(2) All types marked with "*" are covered by IEC 62368-1 G.8.2 and IEC 60950-1 Annex Q.
(3) Acc. To IEC 62368-1 G.8.2 and IEC60950-1, Annex Q: Maximum continuous voltage of the Varistors should be at least 1.25 times rated voltage of equipment/ rated voltage range. Only typical AC Mains Supply voltages are indicated.
(4) Rating deviating to S14K*E2 series .

Table 1 (9 of 9)

Style (1)	IEC 61051-2-2 AT0001: Detail Specification for leaded Disk	Supply voltage (3)	Maximum continuous voltage		Voltage at 1 mA (V)	Voltage at class current (8/20µs)		Max. peak current (8/20µs, 1 time) (A)	Max. peak current (8/20µs, 10 times) (A)	Max. peak current (8/20µs, combination pulse, 10 times) (A)	Max. peak current (2 ms, 10 times) (A)	Maximum capacitance (pF)	Dimensions			
			r.m.s. (V)	d.c. (V)		Class current(A)	Max. volt (V)						(A)	(A)	(A)	(A)
NT20 LV																
*NT20K50E2	S20K50E2		50	65	82	100	135	10000	5000 (4)	6.0kV/3.0kA	55	9000	23	28	9.0	
*NT20K130E2	S20K130E2	120	130	170	205	100	340	10000	5000 (4)	6.0kV/3.0kA	55	3500	23	28	9.0	
*NT20K140E2	S20K140E2		140	180	220	100	360	10000	5000 (4)	6.0kV/3.0kA	55	3250	23	28	9.0	
*NT20K150E2	S20K150E2		150	200	240	100	395	10000	5000 (4)	6.0kV/3.0kA	55	3000	23	28	9.0	
*NT20K175E2	S20K175E2		175	225	270	100	455	10000	5000 (4)	6.0kV/3.0kA	55	2600	23	28	9.0	
*NT20K210E2	S20K210E2		210	270	330	100	595	10000	5000 (4)	6.0kV/3.0kA	55	2300	23	28	9.5	
*NT20K250E2	S20K250E2	230	250	320	390	100	650	10000	5000 (4)	6.0kV/3.0kA	55	1800	23	28	9.5	
*NT20K275E2	S20K275E2	240	275	350	430	100	710	10000	5000 (4)	6.0kV/3.0kA	55	1800	23	28	9.5	
*NT20K300E2	S20K300E2		300	385	470	100	775	10000	5000 (4)	6.0kV/3.0kA	55	1500	23	28	11.0	
*NT20K320E2	S20K320E2		320	420	510	100	845	10000	5000 (4)	6.0kV/3.0kA	55	1300	23	28	11.0	
*NT20K350E2	S20K350E2		350	460	560	100	930	10000	5000 (4)	6.0kV/3.0kA	40	1270	23	28	11.0	
*NT20K385E2	S20K385E2		385	505	620	100	1025	10000	5000 (4)	6.0kV/3.0kA	40	1250	23	28	11.0	
*NT20K420E2	S20K420E2		420	560	680	100	1120	10000	5000 (4)	6.0kV/3.0kA	40	1100	23	28	11.0	
NT20 HV																
*NT20K460E2	S20K460E2		460	615	750	100	1240	10000	5000 (4)	6.0kV/3.0kA	40	1100	23	28	11.0	
*NT20K510E2	S20K510E2		510	670	820	100	1355	10000	5000 (4)	.8.0KV/4.0kA	40	900	23	28	12.0	
*NT20K550E2	S20K550E2		550	745	910	100	1500	10000	5000 (4)	8.0KV/4.0kA	40	700	23	28	12.0	
*NT20K625E2	S20K625E2		625	825	1000	100	1650	10000	5000 (4)	8.0KV/4.0kA	40	650	23	28	13.0	
*NT20K680E2	S20K680E2		680	895	1100	100	1815	10000	5000 (4)	8.0KV/4.0kA	40	600	23	28	13.0	
*NT20K750E2	NA		750	1060	1200	100	2000	10000	3000	8.0KV/4.0kA	40	550	23	28	13.0	
*NT20K1000E2	S20K1000E2		1100	1465	1800	100	2970	10000	3000 (4)	8.0KV/4.0kA	40	400	23	28	15.0	

(1) For explanation of style reference number, see clause 1.5.

(2) All types marked with "*" are covered by IEC 62368-1 G.8.2 and IEC 60950-1 Annex Q.

(3) Acc. To IEC 62368-1 G.8.2 and IEC60950-1, Annex Q: Maximum continuous voltage of the Varistors should be at least 1.25 times rated voltage of equipment/ rated voltage range. Only typical AC Mains Supply voltages are indicated.

(4) Rating deviating to S14K*E2 series .

1.4 Marking

The varistors are marked with their:

- style reference (includes style, tolerance, max. continuous r.m.s. voltage; alternatively style, tolerance, varistor voltage at 1 mA)

They are distinguished as follows: no underline under the SFS..., ETFV... (Standard); an additional underline under the SFS..., ETFV... (for type series Advanced – E2) or a line above the SFS..., ETFV... (for type series SuperioR – E3), or a line above and under the SFS..., ETFV... (for type series SuperioR – E4).

Remark: Below description is only for information (types covered by certification acc. table 1):

SFS14 K275	<u>SFS14</u> K275	<u>SFS14</u> K275	
Standard	Advanced	SuperioR	
ETFV20 K275	<u>ETFV20</u> K275	<u>ETFV20</u> K275	<u>ETFV25</u> K275
Standard	Advanced	SuperioR	SuperioR
T20 K275	<u>T20</u> K275	<u>T20</u> K275	<u>T25</u> K275
Standard	<u>Advanced</u>	SuperioR	SuperioR
	<u>NT20</u> K275		
	Advanced		

- Manufacturer's code or trade mark
- Date of manufacture

1.5 Ordering information

Orders for varistors covered by this specification shall contain, in clear or in coded form, the following minimum information.

Remark: Below description is only for information (types covered by certification acc. table 1):

Example _ * 14 K 275(V431) A(B,C) E2 G GX A S R H M P K K8 K9 T VB

<u>_</u>	Style - (SFS: Fail-safe Varistor; ETFV, T, NT: ThermoFuse varistor, series designation)
<u>14</u>	Disc size (diameter of ceramic disc)
<u>K</u>	Tolerance ± 10 % of voltage at 1 mA (J: ± 5 %; L: ± 15 %; M: ± 20 %; S: special tolerance)
<u>275</u>	Max. continuous r.m.s. voltage
<u>V431</u>	Alternative type designation with varistor voltage at 1 mA instead of max. cont. r.m.s voltage (code: 43×10^1)
<u>A(B,C)</u>	designation for special types
<u>E2 E3 E4</u>	High energy series
<u>G</u>	Taping according IEC 60286, part 2
<u>GX</u>	Customer defined taping not defined with other standard taping styles
<u>A</u>	Ammopack
<u>S</u>	Crimp-Type, is omitted when Crimp-Type Standard
<u>R</u>	Lead spacing (e): mm
<u>H</u>	Component height (h or h ₁): mm
<u>M</u>	Cut lead length (l): mm
<u>P</u>	Test requirements additionally agreed to this detail specification
<u>K</u>	Customer specific properties not defined with other codes (K1 - K99 available except for the two reserved codes below)
<u>K4</u>	Two pins version(without monitor lead) of ThermoFuse varistor
<u>K8</u>	Special combination lead diameter - lead spacing
<u>K9</u>	Components have the same ratings but they are matched for the varistor voltage at 1 mA within one package
<u>T</u>	Resistance to temperature changes - denotes that the varistor exceeds the normally defined temperature range
<u>(:)</u>	additional numbers 00-99
<u>SIOV</u>	may be prefixed

Special varistor types with customer specific tolerances (tolerance designation S in combination with the letters A, B or C) and varistors with special geometrical specifications designated by R, H, M, or K8, are available on request.

1.6 Certified records or released lots

Not required.

1.7 Additional information (not for inspection purposes)

The voltage indicated on the component is the maximum allowable steady state sinusoidal voltage at 50 - 60 Hz. When use is made of a supply voltage, the maximum continuous a.c. r.m.s. voltage = 1.1 x supply voltage. Should the varistor be subjected to voltage above the indicated voltage, it may fail by package rupture or expulsion material, causing a major problem in the equipment.

Coating information (excl. housing):

Material: Epoxy,
Ref. No.: CP-930-1
Factory: Dae Joo

Material: Epoxy,
Ref. No.: PCE-282
Factory: Pelnox

Material: Epoxy,
Ref. No.: EF-150C, EF-150
Factory: Kaihua, Tianjin

Housing information

Material: Poly butylene terephthalate
Ref.No: PBT1403G6
Factory: NanYa

Material: Poly butylene terephthalate
Ref.No: PBT420 SEO
Factory: GE

Material: Poly butylene terephthalate
Ref.No: PBT420 SEO
Factory: GE

Material: Aromatic Liquid Crystal Polymer
Ref.No: LCP 3400 G-330
Factory: RTP SHIELD

NT Series:
Material: Epoxy,
Ref. No.: PCE-282
Factory: Pelnox

Material: Epoxy,
Ref. No.: EF-150C, EF-150F
Factory: Kaihua, Tianjin

1.8 Additional or increased severities or requirements to those specified in the generic and/or sectional specification

None.

SECTION TWO – INSPECTION REQUIREMENTS

2 Inspection requirements

2.1 Procedures

2.1.1 For Qualification Approval the procedure shall be in accordance with the Sectional Specification, IEC Publication 61051-2, Sub-clause 3.2.

2.1.2 For Quality Conformance Inspection the test schedule (Table II) includes sampling, periodicity, severities and requirements. The formation of inspection lots is covered by Sub-clause 3.3.1 of the Sectional Specification.

TABLE II

- Notes
1. - Sub-clause numbers of tests and performance requirements refer to the Generic Specification, IEC Publication 61051-1.
 2. - Inspection Levels and AQL's are selected from IEC Publication 60410 (alternatively IEC 61193-2):
Sampling Plans and Procedures for Inspection by Attributes.
 3. - In this table:
 - p = periodicity (in months)
 - n = sample size
 - c = acceptance criterion (permitted number of defectives)
 - D = destructive
 - ND = non-destructive
 - IL = inspection level
 - AQL = acceptable quality level } IEC 60410 (alternatively IEC 61193-2)
 4. - The bump test and shock test are considered to be alternative. The detail specification shall indicate which test is to be performed.
 5. - Where d.c. has been applied to the varistor, the reference voltage shall be measured in the same direction.
 7. - The manufacturer shall only be required to perform one of these tests.

Sub-clause number and Test (see Note 1)	D or ND	Conditions of test (see Note 1)	IL	AQL	Performance requirements (see Note 1)
			(see Note 2)		
<u>GROUP A INSPECTION</u> (lot-by-lot) <u>Sub-group A1</u> 4.4.1 Visual examination 4.4.2 Marking	ND		II	1,0%	As in 4.3.1 Legible marking and as specified in 1.4 of this specification
<u>Sub-group A2</u> 4.5 Voltage	ND	Voltage at specified current	II	0,65%	As specified in 1.2.2 of this specification
<u>Sub-group A3</u> 4.4.3 Dimensions (gauging)	ND	Not applicable	S-4	1,0%	As specified in 1.2.1 of this specification
<u>GROUP B INSPECTION</u> (lot-by-lot) <u>Sub-group B1</u> 4.11 Robustness of terminations 4.13 Solderability (if applicable) 4.22 Solvent resistance of the marking (if applicable)	D	IEC 60068-2-21, Test Ua1 F = 10 N (d ≤ 0.8 mm) F = 20 N (d = 1 mm) Visual examination Voltage at specified current IEC 60068-2-20, Test Ta, Method 1 T = 235±5°C, d = 2±0.5s IEC 60068-2-45, Test XA (3.1.1, Method 1): T = 23±5°C, t = 5±0,5 min Solvent: 2-propanol Rubbing material: Cotton wool F = 5±0,5 N, 10 strokes. Visual examination	S-3	2,5%	No visible damage $\left \frac{\Delta U}{U} \right \leq 10\%$ The terminations shall be uniformly tinned Legible marking

Sub-clause number and Test (see Note 1)	D or ND	Conditions of test (see Note 1)	IL	AQL	Performance requirements (see Note 1)
			(see Note 2)		
<u>Sub-group B2</u>	D	At class current: See table 1.	S-2	1,0%	As specified in the detail specification
4.7 Voltage under pulse condition					
4.9 Voltage proof		Metal balls method (4.8.1.2) 2500 V, 60 s			As in 4.8

Sub-clause number and Test (see Note 1)	D or ND	Conditions of test (see Note 1)	Sample size & criterion of acceptability (see Note 3)			Performance requirements (see Note 1)
			p	n	c	
<u>GROUP C INSPECTION</u> (periodic)	D	<u>Pulse current</u> 10 pulses 8/20 μs at 2 per min in one direction (current according table 1 and 1.2.3) Visual examination Voltage at specified current <u>Combination pulse</u> 10 pulses (combination pulse), in one direction, 1 per min Visual examination Leakage current or voltage at specified current	6	13	1	No visible damage $\left \frac{\Delta U}{U} \right \leq 10\%$
<u>Sub-group C1</u>						
4.6 Pulse current (or combination pulse).						
<u>Sub-group C2</u>	D	10 pulses 2 ms square wave in one direction, 1 every 2 min, at the maximum peak current defined for 10 pulses (see derating curve) Visual examination Voltage at specified current	12	13	1	No visible damage $\left \frac{\Delta U}{U} \right \leq 10\%$
4.6 Pulse current						

Sub-clause number and Test (see Note 1)	D or ND	Conditions of test (see Note 1)	Sample size & criterion of acceptability (see Note 3)			Performance requirements (see Note 1)
			p	n	c	
<u>Sub-group C3A</u> Part of sample of Sub-group C3 4.8 Capacitance 4.12 Resistance to soldering heat (if applicable) 4.23 Component solvent resistance (if applicable) 4.14 Rapid change of temperature	D	f = 1 kHz Signal level ≤ 1V Zero bias IEC 60068-2-20, Test Tb, Method 1A T = 260±5°C, d = 10±1s Visual examination Voltage at specified current IEC 60068-2-45, Test XA (3.1.1, Method 2): T = 23±5°C t = 5±0,5 min Solvent mixture: 70±5% Diethyleneglycoldibutylether, 30±5% 2-propanol. Recovery: 48h Visual examination Voltage at specified current IEC 60068-2-14, Test Na N = 5 cycles, d = 30 min θ _A = -40±3°C θ _B = UCT ±2°C Visual examination Voltage at specified current	12	7		As specified in 1.2.2 of this specification No visible damage Legible marking $\left \frac{\Delta U}{U} \right \leq 5\%$ No visible damage Legible marking $\left \frac{\Delta U}{U} \right \leq 5\%$ No visible damage Legible marking $\left \frac{\Delta U}{U} \right \leq 5\%$

Sub-clause number and Test (see Note 1)	D or ND	Conditions of test (see Note 1)	Sample size & criterion of acceptability (see Note 3)			Performance requirements (see Note 1)
			p	n	c	
<p><u>Sub-group C3B</u></p> <p>Other part of sample of Sub-group C3</p> <p>4.16 Shock (or bump, see Note 4)</p>		<p>IEC 60068-2-27, Test Ea</p> <p>Pulse shape: half-sine Types with nominal voltage <680V: a = 400 m/s², d = 6 ms N = 6 x 5000 shocks.</p> <p>Types with nominal voltage ≥680V: a = 500 m/s², d = 11ms N = 6 x 3 shocks.</p> <p>(For mounting method see 2.3.3 of the sectional specification)</p> <p>Visual examination</p> <p>Voltage at specified current</p>	12	6		<p>No visible damage Legible marking</p> $\left \frac{\Delta U}{U} \right \leq 5\%$
<p>4.15 Bump (or shock, see Note 4)</p>		<p>IEC 60068-2-29 (withdrawn) Not specified</p>				
<p>4.17 Vibration</p>		<p>IEC 60068-2-6, Test Fc, Method B4</p> <p>Frequency range: 10 Hz to 55 Hz a = 0,75 mm or 98 m/s² (whichever is the less) d = 3x2 h (For mounting method see 2.3.5 of the sectional specification)</p> <p>Visual examination</p> <p>Voltage at specified current</p>				<p>No visible damage Legible marking</p> $\left \frac{\Delta U}{U} \right \leq 5\%$

Sub-clause number and Test (see Note 1)	D or ND	Conditions of test (see Note 1)	Sample size & criterion of acceptability (see Note 3)			Performance requirements (see Note 1)
			p	n	c	
<u>Sub-group C3</u> Combined sample of specimens of Sub-groups C3A and C3B 4.18 Climatic sequence - Dry heat - Damp heat, cyclic, Test Db, first cycle - Cold - Damp heat, cyclic, Test Db, remaining cycles - Final measurement	D	(Low air pressure test not applicable) IEC 60068-2-2, Test Ba 16±2h, T = UCT±2°C; IEC 60068-2-30, Test Db 24h, T = 55±2°C; IEC 60068-2-1, Test Aa 2h, T = -40±3°C; IEC 60068-2-30, Test Db 24h, T = 55±2°C; Visual examination Voltage at specified current Insulation resistance U = 500V (Insulated varistors only) Voltage proof (Insulated varistors only)	12	13	1	No visible damage Legible marking $\left \frac{\Delta U}{U} \right \leq 10\%$ ≥ 100 MΩ No breakdown or flashover
<u>Sub-group C4</u> 4.21 Endurance at upper category temperature	D	T = UCT±2°C, Duration: 1000 h Voltage: max. a.c. voltage Examination at 48 h, 500 h and 1000 h: Visual examination Voltage at specified current Examination at 1000 h: Voltage at class current Insulation resistance U = 500V (Insulated varistors only)	12	13	1	No visible damage Legible marking $\left \frac{\Delta U}{U} \right \leq 10\%$ 1,1 x the initial limit ≥ 1 GΩ

Sub-clause number and Test (see Note 1)	D or ND	Conditions of test (see Note 1)	Sample size & criterion of acceptability (see Note 3)			Performance requirements (see Note 1)
			p	n	c	
<p><u>GROUP D INSPECTION</u></p> <p><u>Sub-group D1</u></p> <p>4.19 Damp heat, steady state</p>	D	<p>IEC 60068-2-78, Test Ca T = 40±2°C, RH = 93(+2/-3)%, 56d</p> <p><u>4 specimens:</u> No voltage applied</p> <p><u>Other 4 specimens:</u> Applied voltage: 10% of the max. d.c. voltage</p> <p>Visual examination</p> <p>Voltage at specified current</p> <p>Insulation resistance U = 500V (Insulated varistors only)</p>	24	8	1	<p>No visible damage Legible marking</p> $\left \frac{\Delta U}{U} \right \leq 10\%$ <p>≥ 100 MΩ</p>
<p><u>Sub-group D2</u></p> <p>4.4.4 Dimensions (detail)</p> <p>4.5 Voltage (if applicable)</p>	ND	<p>At specified current</p> <p>At following temperatures: LCT (+0/-3°C) and UCT (+3/-0°C)</p>	24	8	1	<p>As specified in 1.2.1 of this specification</p> <p>As specified in 1.2.2 of this specification</p> $\frac{U_{25^{\circ}\text{C}} - U_{-40^{\circ}\text{C}}}{\Delta T} \cdot \frac{100\%}{U_{25^{\circ}\text{C}}} \leq 0,09\% \text{K}^{-1}$ $\frac{U_{25^{\circ}\text{C}} - U_{85^{\circ}\text{C}}}{\Delta T} \cdot \frac{100\%}{U_{25^{\circ}\text{C}}} \leq 0,09\% \text{K}^{-1}$
<p><u>Sub-group D3</u></p> <p>4.20 Fire hazard (Needle flame test)</p>	D	<p>IEC 60695-11-5 Severity: Vertical 10 s</p>	24	5	0	<p>Duration of burning: 5 s max.</p>

3 Appendix: Lead configuration ThermoFuse series

ETFV14*-types

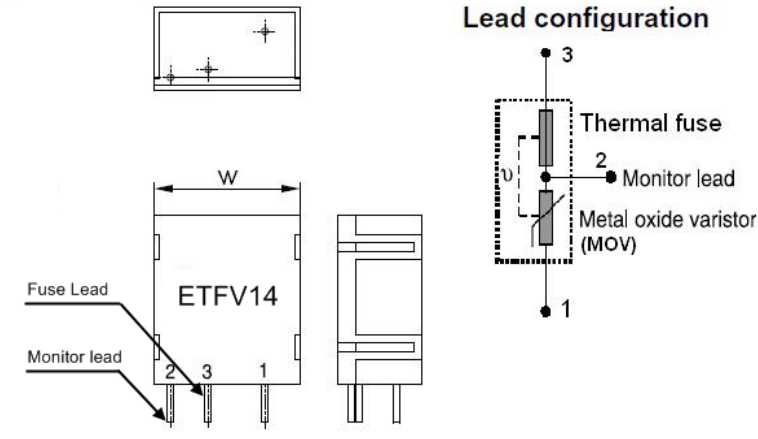

ETFV20*-types

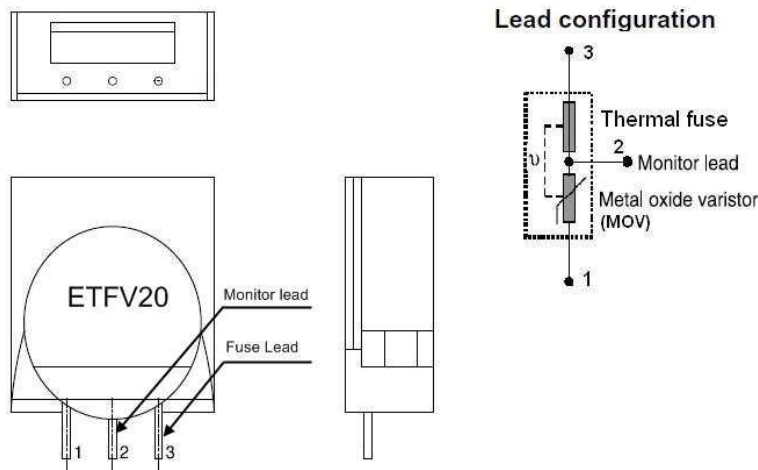

ETFV25*-types

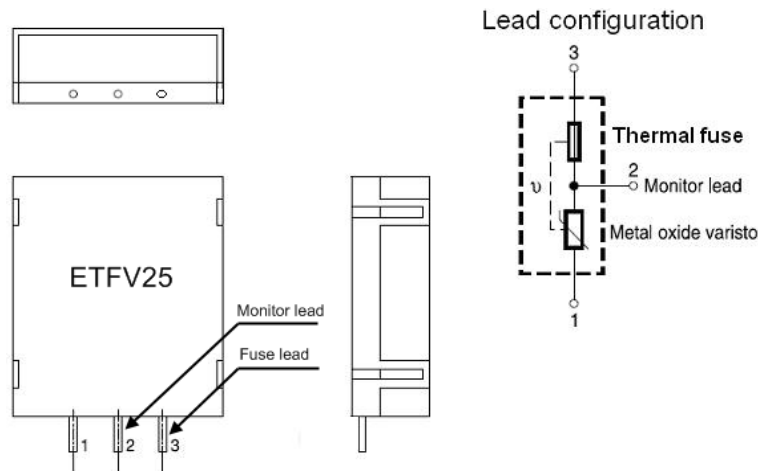

T14/T20 LV*-types

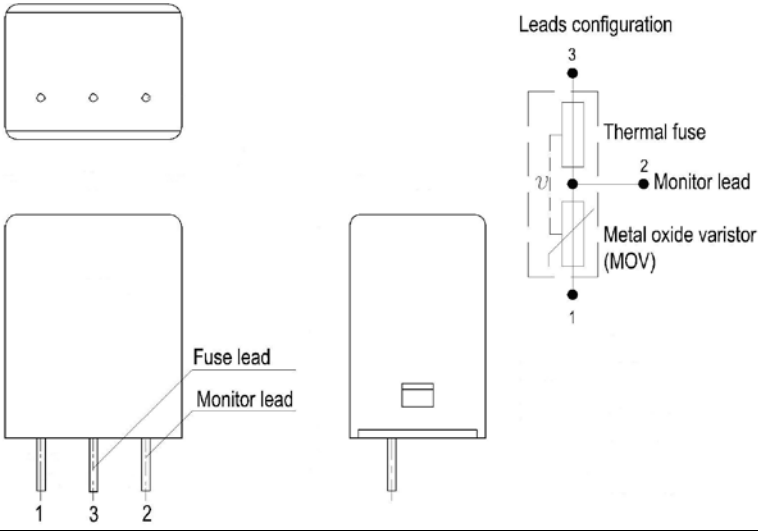

T20 MV/HV*-types

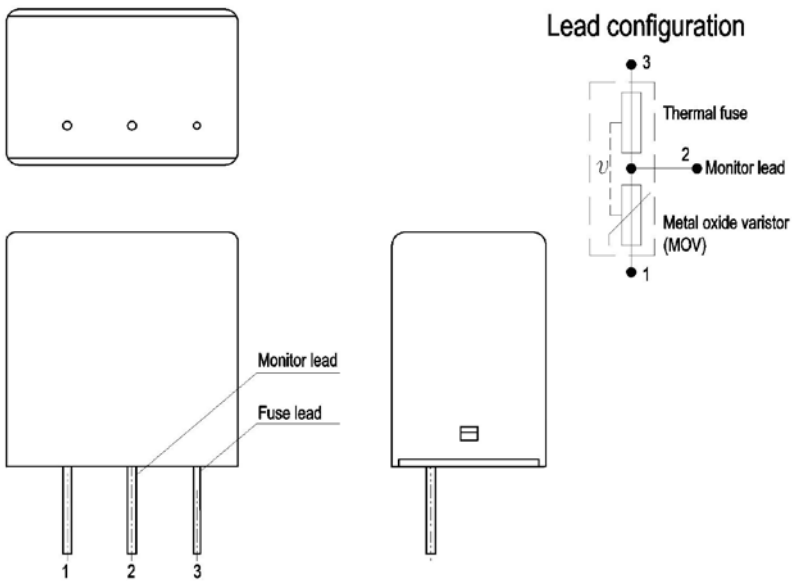

NT14/NT20*-types:

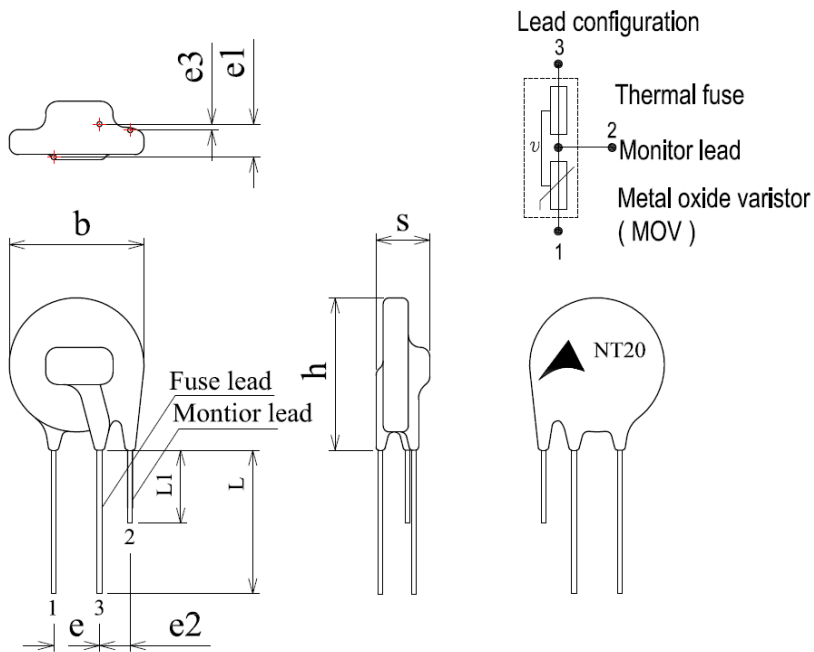

NT14*K4/NT20*K4-types:

